

**Data sheet - Cam Roller LR5203-2Z-X (cylindrical, with shield)**

Designation	LR5203-2Z-X
D [mm]	47
d [mm]	17
B [mm]	17,5
r [mm]	0,6
Dynamic load Crw [N]	12800
Static load C0rw [N]	8400
Speed limit [min-1]	7500

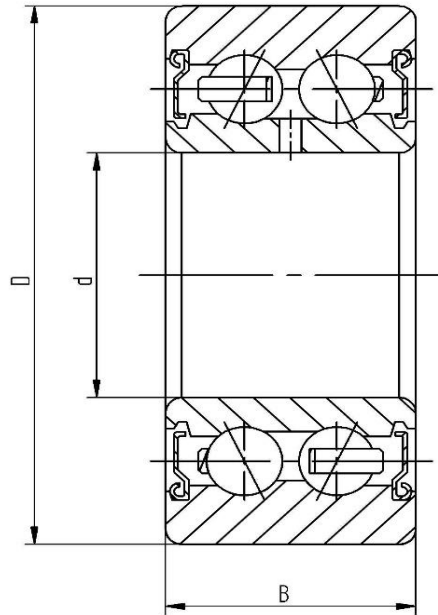

Every specification has been edited and verified carefully. STI Bearings GmbH assumes no liability for potential errors or incompleteness. Technical modifications are subject of changes.  
© 2020 by STI Bearings GmbH  
Reproduction, even excerpts, only with our approval.