

Data sheet - Cam Roller LR5201-2Z-X (cylindrical, with shield)

Designation	LR5201-2Z-X
D [mm]	35
d [mm]	12
B [mm]	15,9
r [mm]	0,6
Dynamic load Crw [N]	8700
Static load C0rw [N]	5200
Speed limit [min-1]	10000

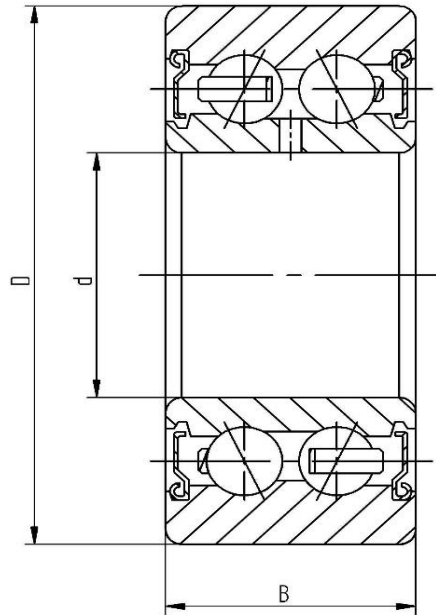

Every specification has been edited and verified carefully. STI Bearings GmbH assumes no liability for potential errors or incompleteness. Technical modifications are subject of changes.
© 2020 by STI Bearings GmbH
Reproduction, even excerpts, only with our approval.