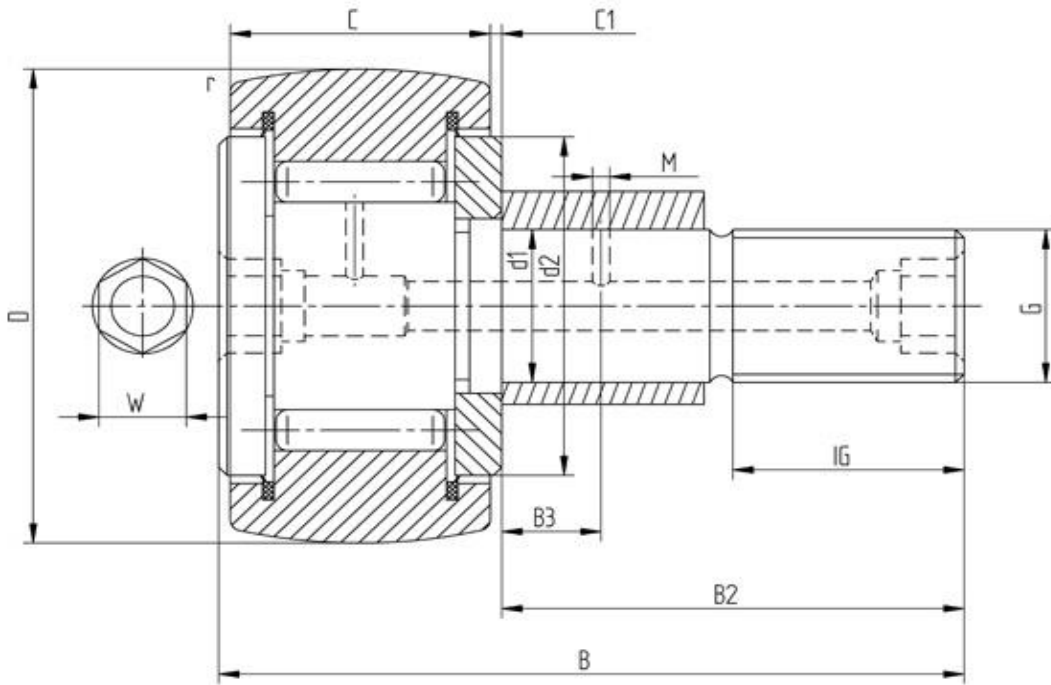

Data sheet - Cam Follower KRVE80PP (full needle, eccentric bush, seal)

Designation	KRVE80PP
D [mm]	80
d1 [mm]	30
B [mm]	100
B2 [mm max.]	63
B3 [mm]	15
C [mm]	35
C1 [mm]	1
r [mm]	1,1
d2 [mm]	53
M [mm]	4
G	M30x1,5
IG [mm]	32
W [mm]	8
Eccentric bush de [mm]	35
Eccentric bush Be [mm]	29
Eccentric bush e [mm]	1,5
Dynamic load Crw [N]	49500
Static load C0rw [N]	120000
Speed limit [min-1]	1700

Every specification has been edited and verified carefully. STI Bearings GmbH assumes no liability for potential errors or incompleteness. Technical modifications are subject of changes.
 © 2020 by STI Bearings GmbH
 Reproduction, even excerpts, only with our approval.