

Data sheet - Cam Follower KRVE16 (full needle, eccentric bush)

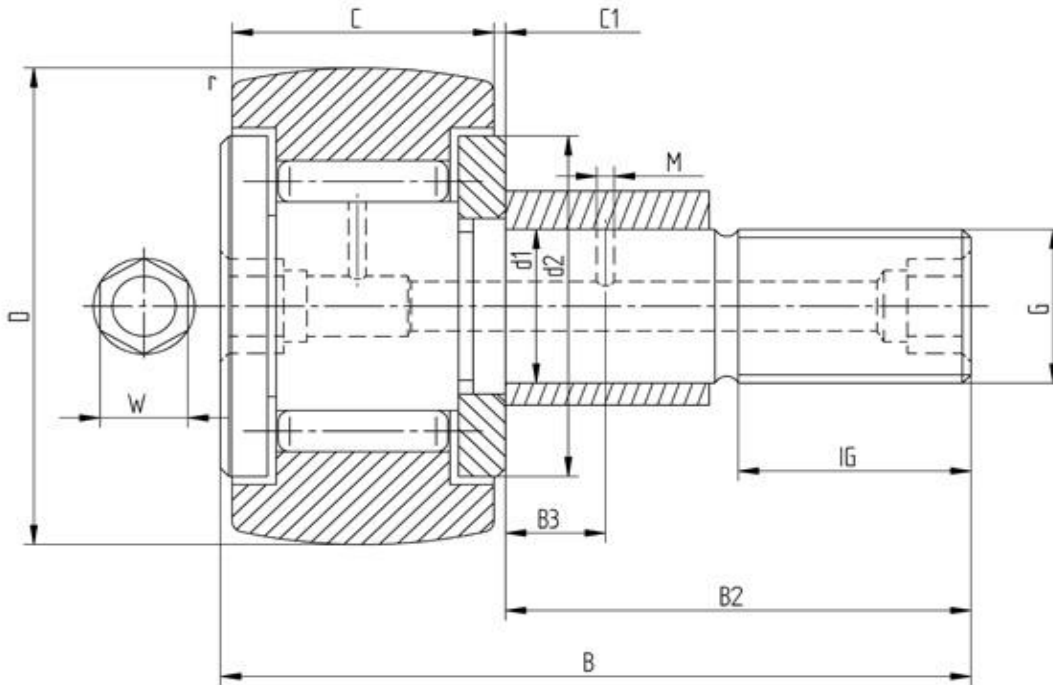

Designation	KRVE16
D [mm]	16
d1 [mm]	6
B [mm]	28
B2 [mm max.]	16
B3 [mm]	-
C [mm]	11
C1 [mm]	0,6
r [mm]	0,15
d2 [mm]	12
M [mm]	-
G	M6
IG [mm]	8
W [mm]	4
Eccentric bush de [mm]	9
Eccentric bush Be [mm]	7
Eccentric bush e [mm]	0,5
Dynamic load Crw [N]	4850
Static load C0rw [N]	6500
Speed limit [min ⁻¹]	8500

Every specification has been edited and verified carefully. STI Bearings GmbH assumes no liability for potential errors or incompleteness. Technical modifications are subject of changes.
 © 2020 by STI Bearings GmbH
 Reproduction, even excerpts, only with our approval.