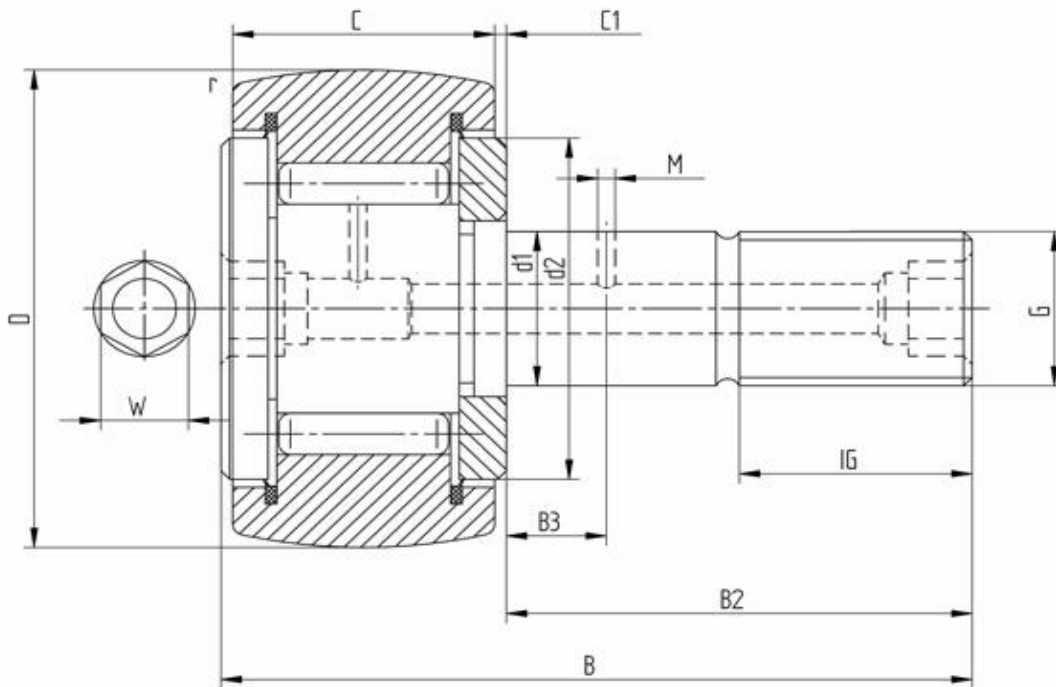

Data sheet - Cam Follower KRV40PP (full needle, seal)

Designation	KRV40PP
D [mm]	40
d1 [mm]	18
B [mm]	58
B2 [mm max.]	36,5
B3 [mm]	8
C [mm]	20
C1 [mm]	0,8
r [mm]	1
d2 [mm]	32
M [mm]	3
G	M18x1,5
IG [mm]	19
W [mm]	6
Eccentric bush de [mm -	
Eccentric bush Be [mm -	
Eccentric bush e [mm] -	
Dynamic load Crw [N]	14800
Static load C0rw [N]	26500
Speed limit [min-1]	2900

Every specification has been edited and verified carefully. STI Bearings GmbH assumes no liability for potential errors or incompleteness. Technical modifications are subject of changes.
 © 2020 by STI Bearings GmbH
 Reproduction, even excerpts, only with our approval.