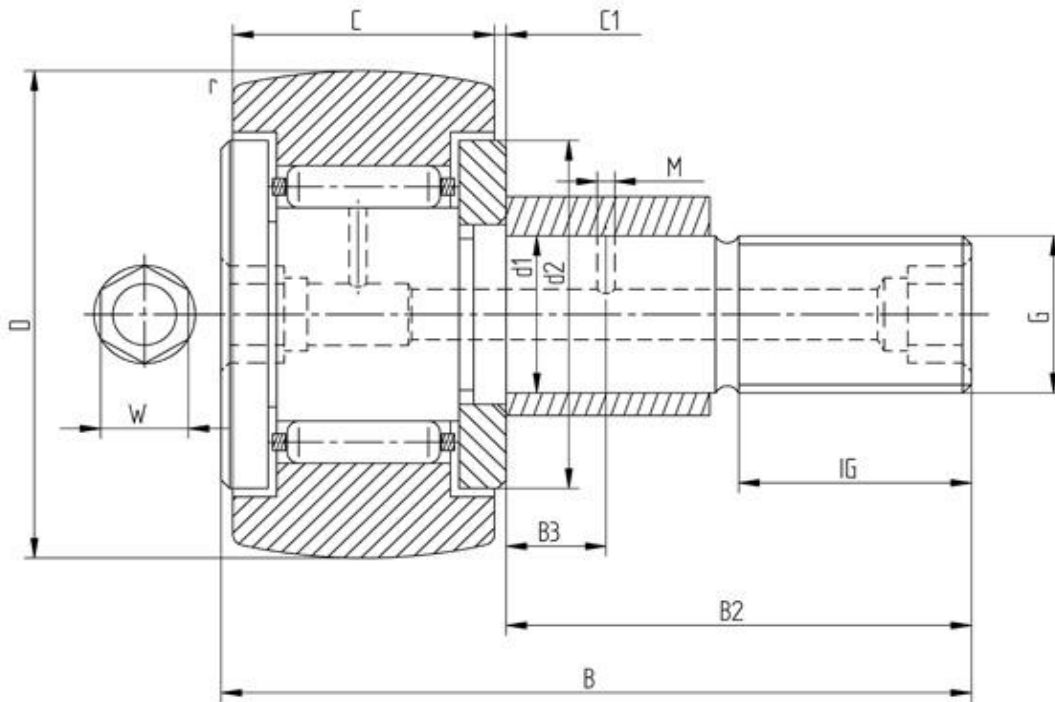

Data sheet - Cam Follower KRE85 (with cage, eccentric bush)

Designation	KRE85
D [mm]	85
d1 [mm]	30
B [mm]	100
B2 [mm max.]	63
B3 [mm]	15
C [mm]	35
C1 [mm]	1
r [mm]	1,1
d2 [mm]	53
M [mm]	4
G	M30x1,5
IG [mm]	32
W [mm]	8
Eccentric bush de [mm]	35
Eccentric bush Be [mm]	29
Eccentric bush e [mm]	1,5
Dynamic load Crw [N]	40500
Static load C0rw [N]	80000
Speed limit [min ⁻¹]	2600

Every specification has been edited and verified carefully. STI Bearings GmbH assumes no liability for potential errors or incompleteness. Technical modifications are subject of changes.
 © 2020 by STI Bearings GmbH
 Reproduction, even excerpts, only with our approval.