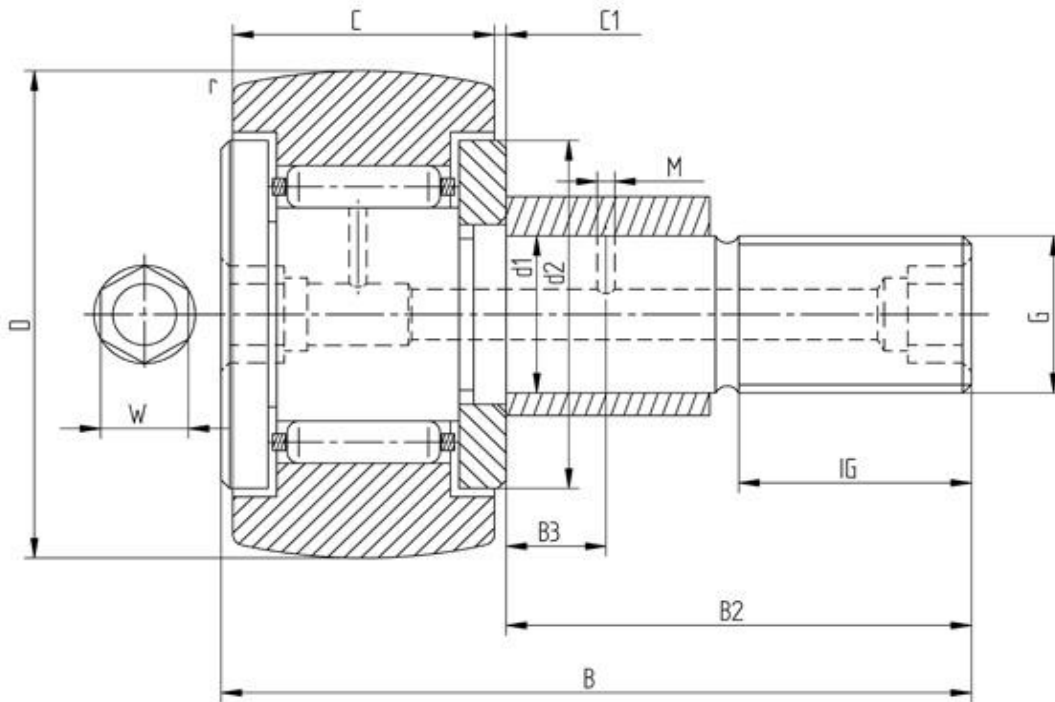

Data sheet - Cam Follower KRE35 (with cage, eccentric bush)

Designation	KRE35
D [mm]	35
d1 [mm]	16
B [mm]	52
B2 [mm max.]	32,5
B3 [mm]	8
C [mm]	18
C1 [mm]	0,8
r [mm]	0,6
d2 [mm]	27
M [mm]	3
G	M16x1,5
IG [mm]	17
W [mm]	6
Eccentric bush de [mm]	20
Eccentric bush Be [mm]	14
Eccentric bush e [mm]	1
Dynamic load Crw [N]	9700
Static load C0rw [N]	14100
Speed limit [min ⁻¹]	7000

Every specification has been edited and verified carefully. STI Bearings GmbH assumes no liability for potential errors or incompleteness. Technical modifications are subject of changes.
 © 2020 by STI Bearings GmbH
 Reproduction, even excerpts, only with our approval.