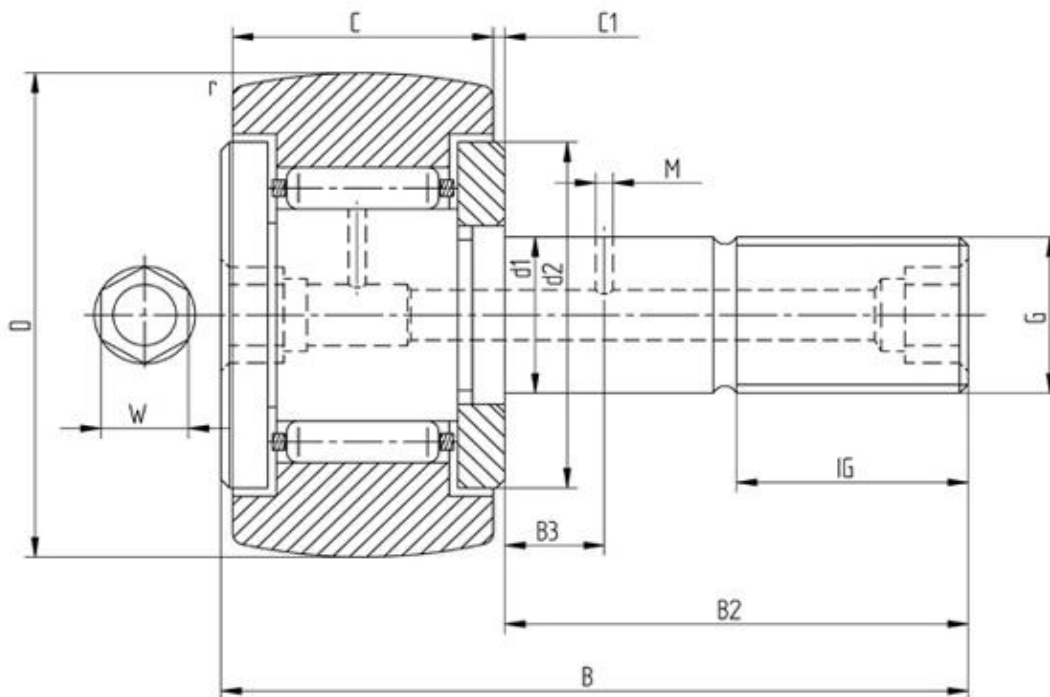

Data sheet - Cam Follower KR52 (with cage)

Designation	KR52
D [mm]	52
d1 [mm]	20
B [mm]	66
B2 [mm max.]	40,5
B3 [mm]	9
C [mm]	24
C1 [mm]	0,8
r [mm]	1
d2 [mm]	37
M [mm]	4
G	M20x1,5
IG [mm]	21
W [mm]	8
Eccentric bush de [mm -	
Eccentric bush Be [mm -	
Eccentric bush e [mm] -	
Dynamic load Crw [N]	16800
Static load C0rw [N]	28500
Speed limit [min-1]	4900

Every specification has been edited and verified carefully. STI Bearings GmbH assumes no liability for potential errors or incompleteness. Technical modifications are subject of changes.
 © 2020 by STI Bearings GmbH
 Reproduction, even excerpts, only with our approval.