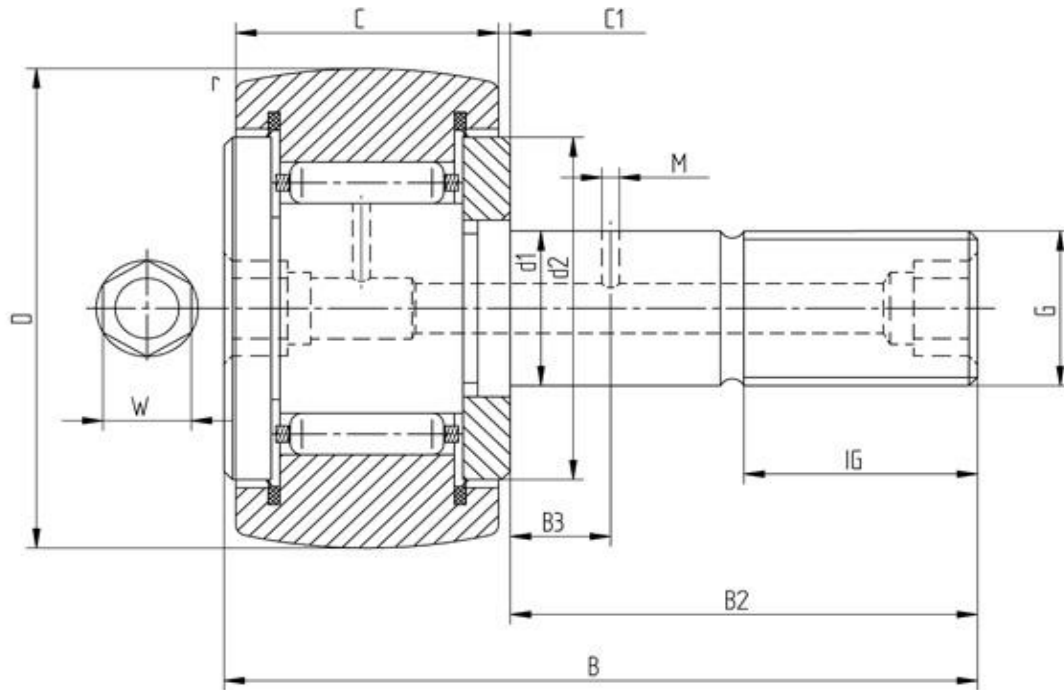

Data sheet - Cam Follower KR26PP (with cage, seal)

Designation	KR26PP
D [mm]	26
d1 [mm]	10
B [mm]	36
B2 [mm max.]	23
B3 [mm]	-
C [mm]	12
C1 [mm]	0,6
r [mm]	0,3
d2 [mm]	17
M [mm]	-
G	M10x1
IG [mm]	12
W [mm]	4
Eccentric bush de [mm -	
Eccentric bush Be [mm -	
Eccentric bush e [mm] -	
Dynamic load Crw [N]	5100
Static load C0rw [N]	6200
Speed limit [min-1]	11000

Every specification has been edited and verified carefully. STI Bearings GmbH assumes no liability for potential errors or incompleteness. Technical modifications are subject of changes.
 © 2020 by STI Bearings GmbH
 Reproduction, even excerpts, only with our approval.